

RevNo	Revision Notes	Date	Checked
1	RoHS Compliant	052105	GC

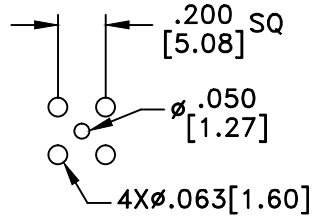

RECOMMENDED HOLE PATTERN

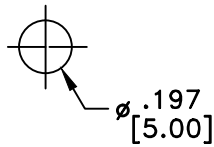

RECOMMENDED MOUNTING HOLE

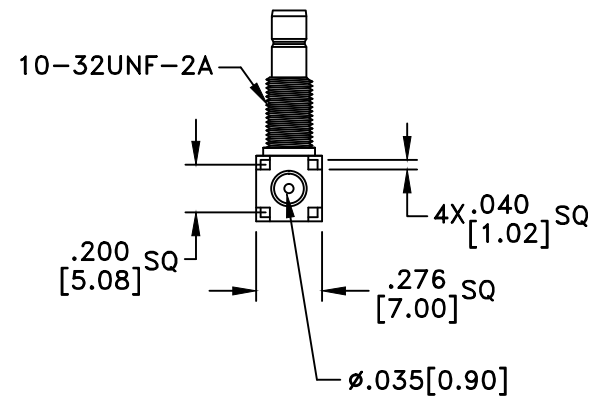
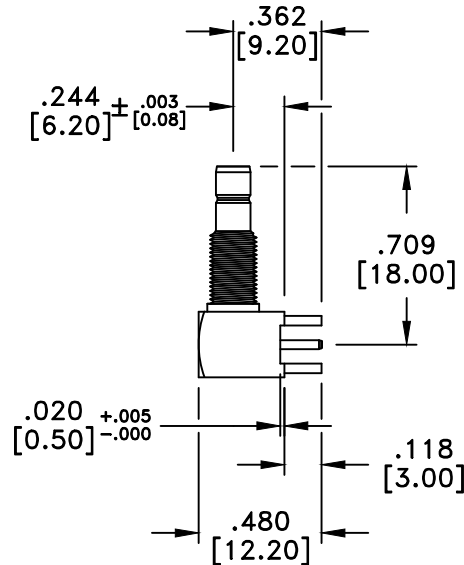
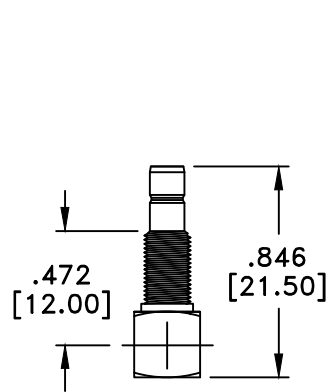

RoHS Compliant

NOTE: INCLUDES HEX NUT AND INTERNAL TOOTH LOCKWASHER

**MATERIAL**

BODY	BRASS
BODY PLATING	GOLD
CONTACT	BRASS
CONTACT PLATING	GOLD
DIELECTRIC	TEFLON (PTFE)

75 Ohm IMPEDANCE  
 500V PEAK VOLTAGE RATING  
 TEMPERATURE RANGE: -55°C TO +155°C  
 INTERFACE DIMENSIONS SIMILAR TO MIL-C-39012

MILLIMETER WAVE TECHNOLOGIES  
 6501 W. FRYE ROAD, #23  
 CHANDLER, AZ 85226

SMB MALE R/A BULKHEAD  
 PCB MOUNT 4 LEGS  
 75 OHMS

Designed by G.COLEMERE	Checked by W. CANON	Approved by A. LEE	File name MWB-5510-G-75	TITLE MWB-5510-G-75
<p>TOLERANCES            DIMENSIONS ARE IN INCHES UNLESS            OTHERWISE SPECIFIED            DECIMALS ANGULAR            .XX ± .02 ± .06            .XXX ± .005 ± .06            DO NOT SCALE THIS DRAWING</p>			<p>ALL DIMENSIONS ON THIS DRAWING ARE FOR REFERENCE            PURPOSES ONLY AND ARE SUBJECT TO CHANGE.</p>	
			REV. 1	Scale NONE
			DATE 021303	Sheet 1 of 1